

ebios  fire<sup>®</sup>  
burning passion

**“DETAILS ARE NOT  
DETAILS  
– THEY MAKE THE  
DESIGN”**

*CHARLES EAMES*

# CONTENT

*INTRODUCTION* 4

COMPANY 4

*INFORMATION* 6

BIOETHANOL 6

SAFETY 8

QUALITY 10

TECHNOLOGY 12

*DESIGN COLLECTION* 14

WALL MODELS 34

FLOOR MODELS 40

TABLE TOP MODELS 44

FIRE OBJECTS 46

*ARCHITECTS COLLECTION* 50

FROM SKETCH TO REALITY 52

BUILT-IN FIREPLACES 54

MADE TO MEASURE FIREPLACE INSERTS 58

DROP-IN BURNERS 66

# COMPANY

## SPARTHERM - THE FIRE COMPANY

Since the year of foundation in 1986, the German manufacturer of innovative heating solutions SPARTHERM has become a synonym for innovative, high quality stoves, fireplace inserts, cassettes, gas- and – of course - bioethanol fires.

In two factories with 25,000m<sup>2</sup> production space each, equipped with state-of-the-art production machinery, Spartherm's over 900 employees pride themselves in developing and manufacturing annually over 60.000 heating products which meet the most discerning customer's expectations of quality, safety, functionality and design.



## BRAND

In order to respond to an increasing demand for flue-less fireplace alternatives, Spartherm have re-launched their range of exclusive bioethanol fires branded ebios-fire® on an international level. Comprising a wide selection of standard fire models (wall and floor models) as well as built-in bioethanol fireplaces which are also offered in custom-made dimensions, all ebios-fire® bioethanol fireplaces provide highest quality, safety and beautiful design which allow creation of an uncomplicated, versatile and stunning focal point in any interior.

In close cooperation with architects and interior designers, the dedicated ebios-fire® experts at Spartherm realise bespoke bioethanol fire applications in luxury developments, private residences, regal palaces, offices, hotels, restaurants and spas worldwide.

ebios-fire® products are sold via an extensive, independent retail network of specialist- and designer stores in a vast and increasing number of countries.

## PHILOSOPHY

We are proud to be a very successful family-run business, driven by our dedication to highest quality and product safety, which is paired with our passion about exclusive, functional design.

This passion and dedication enables our expert team to create magical moments around mesmerising flames for our customers.

We thrive on excellence in customer service, which we provide at all levels to business partners and customers with whom we share our burning passion for fire.



# BIOETHANOL

## - THE GREEN CHOICE

Fireplaces from ebios-fire® are exclusively fuelled with bioethanol – or simply “ethanol” – which is green, non-fossil fuel made by fermenting the sugar and starch components of organic matter – mainly sugarcane, potatoes and crops like grain or even hay.

Bioethanol creates only a small amount of CO<sub>2</sub> and water vapour when burning, which means that – if used in ebios-fire® burners – it has a clean combustion without any smoke, smell and soot emission and with no need for a chimney or flue.



As an alcohol-based liquid, bioethanol changes its form from liquid to gas at around 17°C. The developing vapours are heavier than air and remain therefore on top of the surface of the liquid bioethanol. Therefore, it is only the bioethanol gas, which is burning when lit and not the liquid itself.

As a renewable energy source, today bioethanol has many uses: blended with petrol, it makes transport fuel more sustainable. It is used in production processes of the cosmetics-, medical- and food industries. And – last but not least – when used in ebios-fire® appliances, it creates a beautiful, lively flame which burns without odour or leaving a residue.

## CLEAN EMISSION

As bioethanol is entirely composed of biological matter, its combustion results in a clean emission of only water vapour and carbon dioxide. Carbon dioxide or CO<sub>2</sub> is absorbed by plants, which process it via photosynthesis to help the plant grow. This infinite cycle of creation and combustion of energy – in a way “recycling of energy” – renders bioethanol a carbon-neutral fuel.

## EFFICIENT GREEN ENERGY

All ebios-fire® appliances are technically engineered in such a manner that their combustion temperature secures not only a minimum fuel consumption but also a clean combustion of bioethanol. This means in turn that a chimney or flue are not needed and thus that 100% of the heat generated are kept indoors.

## STORAGE AND HANDLING

Bioethanol is a Class 1B Flammable Liquid (for flammability) and rated Class 3 PGII (for transport) and is therefore regulated by various standards around the world.

Local regulations for storage of bioethanol might be in place.

## BIOETHANOL FOR EBIOS-FIRE® APPLIANCES

All ebios-fire® burners should be operated only with bioethanol of at least 96% but max. 97.5% purity. We recommend ebios-fire® bioethanol of 96%.

## FUEL CONSUMPTION

Unlike wood or gas burning fireplaces, the flame behaviour seen in bioethanol fireplaces is very much influenced by airflow around the burner and draft conditions, which prevail in the individual setting. Both can have an undesired effect on the combustion temperature and the fuel consumption.

Supporting our customers with our expertise and technical knowhow enables them to create not only a stunning focal point but also a perfectly functional and safe to operate bioethanol fireplace.

For more information about fuel consumption for a specific ebios-fire® model, please refer to the details on this product.



# SAFETY

The combination of liquid combustible, people and an open flame can be a dangerous one. Therefore, we have designed all ebios-fire® burners and fireplaces with a maximum of user safety and intuitive operating processes in mind.

Each ebios-fire® appliance is extensively tested in our factory laboratory where we monitor fuel consumption, heat output, flame behaviour and material durability. Furthermore, the majority of all ebios-fire® burners and fireplace models is safety tested and certified by TÜV Germany.

Since 2009, Spartherm has been a member of the Expert Panel in charge of formulating a new European Standard for bioethanol fireplaces, which will be introduced throughout Europe in the near future.

Through our cooperation with other European manufacturers of bioethanol fires, biochemists as well as Standardisation and Consumer Safety Organisations we were able to intensify our expertise – which we utilise daily in order to create products which are designed giving safety, functionality and quality highest priority.

All ebios-fire® appliances leave the factory lab-tested and carefully packaged in order to prevent transport damage. Each ebios-fire® burner features safety pictograms which guide the user confidently and safely to operate the fireplace. Furthermore, a dedicated User Manual is included with each fireplace, in which the user will find valuable information about the fireplace, its installation, use and maintenance as well as about the bioethanol needed in order to fuel the fireplace.

## CUSTOMER RESPONSIBILITY

With all the effort dedicated to creating the safest bioethanol fireplace models providing a truly magical experience for our customers, it is, however, our *customers* who bear the final responsibility when it comes to safely operating their ebios-fire® appliance.

Therefore, we would like to emphasise the importance of adhering to the following safety rules:



DO read the manual and adhere to all instructions given therein. Let everyone who will operate the fire read the manual as well.

We strongly advise against any amendment of any components or the design of ebios-fire® appliances. This includes the use of decorative ceramic items like logs or pebbles in the flames.

## ROOM AIR QUALITY

Contrary to common believe, it is not primarily the consumption of oxygen which decreases the room air quality, but rather the formation of CO<sub>2</sub>. Carbon Dioxide is a trace gas which is naturally contained in air, but it is also produced by plants, animals, humans and – of course – any combustion process like the burning of bioethanol.

2 humans produce around 75g of CO<sub>2</sub> per hour.

A fire which burns 0.5 litres of bioethanol per hour produces 740g of CO<sub>2</sub>.

The secondary factor influencing the room air quality is the consumption of Oxygen. Air contains in average 21% of oxygen. This means that a room of 40m<sup>2</sup> with a ceiling height of 2.5m (100m<sup>3</sup>) contains 27kg of oxygen.

2 resting adult humans consume around 55g of oxygen per hour.

A fire which burns 0.5 litres of bioethanol per hour consumes 800g of oxygen.

And last but not least, the air exchange rate is the factor, which helps to compensate for both the CO<sub>2</sub> emission and the oxygen consumption.

In order to keep the indoors climate at its best, i.e. the room air quality as high as possible during operation of a bioethanol fire, it is essential carefully to plan the size of the burner considering the room size, its volume and ventilation. The qualified ebios-fire® staff is here to help with expert advice.



# QUALITY

All ebios-fire® models are manufactured in our two modern production facilities which are equipped with cutting-edge technology machinery like welding robots, laser cutters and powder-coating lines. Our well-trained staff lovingly hand-finishes each fireplace model before it undergoes an extensive test programme in our laboratory.

.....



**“ A HOUSE IS NOT A  
HOME UNLESS IT  
CONTAINS FOOD  
AND FIRE FOR THE  
MIND AS WELL AS  
THE BODY. ”**

*BENJAMIN FRANKLIN*

# TECHNOLOGY

As the core element in our entire range of bioethanol fireplaces, the ebios-fire® wick or automatic burners offer a wealth of possibilities. Without the need for a flue or chimney installation is possible just about anywhere.

## THE WICK BURNER

Featuring a patented wick-feeding technology which allows a safe, deflagration-free ignition this burner type has been safety tested and approved by TÜV Germany against the German Standard DIN 4734-1. The ebios-fire® Wick Burner can be considered one of the safest bioethanol burners currently on the market. It comes in flame widths of 400 / 500 / 600 and 700mm, which makes it possible to place several burners in a row in order to achieve a continuous, ribbon-like flame display. The volume of the burner tanks, which are pressure tested against leakage, varies in accordance with the burner size, together with the heat output. This burner type is an integral part of most models in our design collection.



SCHOTT ROBAX® glass panels surrounding the burner do not only reflect the mesmerising flames beautifully but also add to safety and functionality of the burner/s.

### SAFETY FEATURES

- pressure tested tank assembly
- glass gauge with fuel level indicator
- screw-cap for fuel inlet
- pressure valve
- sealed fuel tank and wick system prevents fuel spillage if tilted

## THE AUTOMATIC BURNER

The automatic ebios-fire® burner featuring pumps which feed bioethanol into a trough of either 500 or 1000mm width can be operated by remote control (on/off). The same patented technology is also applied for the round ebios-fire® burner. The fuel supply is kept in 5 liter jerry cans which are placed either underneath the fire or at a remote location. Alternatively, the burner can feature a tank which then is an integral part of the appliance.

### SAFETY FEATURES

- fuel level sensor in flame tray
- humidity sensors at critical locations (leakage detectors)
- temperature sensors (no flame, no fuel and automatic cut-off if overheating)
- automatic cut-off after 8 hours of operation
- acoustic error signal



**“ANY SUFFICIENTLY ADVANCED  
TECHNOLOGY IS  
INDISTINGUISHABLE FROM MAGIC.”**

*ARTHUR C. CLARKE*

# DESIGN COLLECTION

Transform your interior with a warming centrepiece chosen from the ebios-fire® Design Collection. This ready to use fireplace model selection does not require a flue or chimney and is easily installed within a matter of minutes.

Whether wall-mounted or freestanding, should you move home, just take your ebios-fire® designer piece with you. Or relocate your focal point from one room to another or onto the terrace on long summer evenings creating instant cosiness.

Create your favourite look without the need for a flue, chimney, electrical connection or extensive building works. Just unwrap, place into position or fix to the wall, read the manual and you are ready to enjoy a real fire.

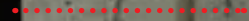

*The award winning, elegant Elipse Z can be placed anywhere in a room allowing a view of its mesmerising flames all around.*





*With its oval body shape and square reflective glass back panel, the ebios-fire® Elipse Wall beautifully combines elegant style with functionality and safety.*





*Square, stylish, classy – and ideal for smaller rooms: The Quadra Wall is one of the most compact models of the ebios-fire® Designer Collection.*







*With its streamlined and clean lines, the Elipse Case beautifully combines function with style. Featuring chrome side details, which reflect details of the surrounding ambience, the Elipse Case is both modern and smart – designed to add sophistication to most contemporary surrounds.*







*As one of the bestselling wall-mounted bio fireplaces of the ebios-fire® Designer Collection the Oxford Series features sleek, uncluttered lines which will enhance most contemporary settings. Both modern and smart, the Oxford series offers maximum practicality and safety at minimum installation effort.*









*The perfect accessory for contemporary living, the Cambridge fireplace models are ideal for installation in apartments, houses and commercial premises such as bars and restaurants. The two different burner sizes of 400mm and 600mm cater perfectly for smaller and medium room sizes.*













# DESIGN COLLECTION SPECIFICATIONS



CAMBRIDGE 400  
WALL MODEL



CAMBRIDGE 600  
WALL MODEL



ELIPSE WALL  
WALL MODEL



OXFORD 600  
WALL MODEL



OXFORD 700  
WALL MODEL



QUADRA WALL  
WALL MODEL





ELIPSE CASE  
FLOOR MODEL



ELIPSE Z  
FLOOR MODEL



ARCHITECTURE SL  
FLOOR MODEL



TOWER  
FLOOR MODEL



ELIPSE BASE  
TABLE TOP MODEL



QUADRA BASE  
TABLE TOP MODEL



FENIX BORA  
FIRE OBJECT



FENIX SCIROCCO  
FIRE OBJECT



FIRE BASE TABLE  
FIRE OBJECT



LIBERTY  
FIRE OBJECT

# ELIPSE WALL

---



<b>Finish</b>	<i>Matt white, matt black, brushed stainless steel or chrome against a black glass panel</i>
<b>Material</b>	<i>Steel, stainless steel and ROBAX® Glass</i>
<b>Weight</b>	<i>24 kg</i>
<b>Burner Type</b>	<i>Wick burner</i>
<b>Tank Volume</b>	<i>2.6 litres</i>
<b>Min. Room Volume</b>	<i>84 m<sup>3</sup></i>
<b>Burning Duration</b>	<i>5 hours</i>

With its oval body shape and square reflective glass back panel, the ebios-fire® Elipse Wall beautifully combines elegant style with functionality and safety.

Available in four different finishes the Elipse Wall incorporates the patented wick-burner which is lined by two hardened glass panels reflecting a mesmerising line of lively dancing flames.

The Elipse Wall is fuelled by bioethanol, an environmentally friendly, renewable energy source.

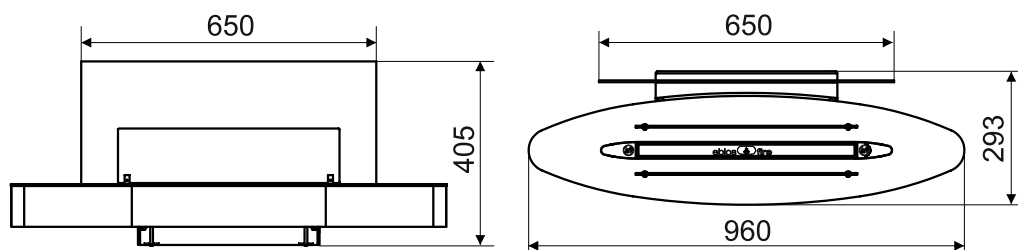

# QUADRA WALL

---



<b>Finish</b>	<i>Brushed stainless steel or black against a black glass panel</i>
<b>Material</b>	<i>Steel, stainless steel and ROBAX® Glass</i>
<b>Weight</b>	<i>25 kg</i>
<b>Burner Type</b>	<i>Wick burner</i>
<b>Tank Volume</b>	<i>2.6 litres</i>
<b>Min. Room Volume</b>	<i>84 m<sup>3</sup></i>
<b>Burning Duration</b>	<i>5 hours</i>

Square, stylish, classy – and ideal for smaller rooms: The Quadra Wall is one of the most compact models of the ebios-fire® Designer Collection. Easily fitted to any type of wall in literally a matter of minutes, its minimalist, clean lines make the Quadra Wall an ideal companion on rainy days and long, dark evenings.

Its stainless steel firebox allows a wide flame picture, which is flanked by two hardened glass panels. Adding to safety, they create beautiful reflections of a ribbon-like calmly dancing fire.

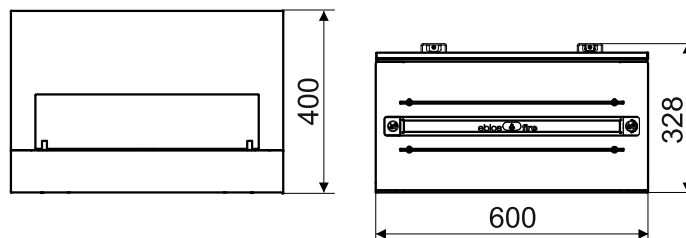

# OXFORD 600



<b>Finish</b>	<i>High gloss white, high gloss black, brushed stainless steel or chrome</i>
<b>Material</b>	<i>Steel, stainless steel and ROBAX® Glass</i>
<b>Weight</b>	<i>21 kg wall-mounted - 29 kg built-in</i>
<b>Burner Type</b>	<i>Wick burner</i>
<b>Tank Volume</b>	<i>2.47 litres</i>
<b>Min. Room Volume</b>	<i>96 m<sup>3</sup></i>
<b>Burning Duration</b>	<i>5 hours</i>

As one of the bestselling wall-mounted bio fireplaces of the ebios-fire® Designer Collection the Oxford Series features sleek, uncluttered lines which will enhance most contemporary settings. Both modern and smart, the Oxford series offers maximum practicality and safety at minimum installation effort.

Essentially a rectangular-shaped wall-hung fireplace with a low glass screen in front of the flames, the Oxford comes in two sizes: 600 and 700 which refer to the burner width in millimetres. This makes this series suitable for medium size and larger rooms.

Both Oxford models are also available as built-in fires, which leave only 50mm protruding out of the wall cavity.

**Wall mounted**

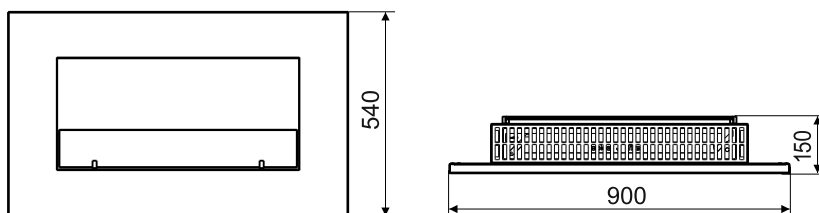

**Built-in**

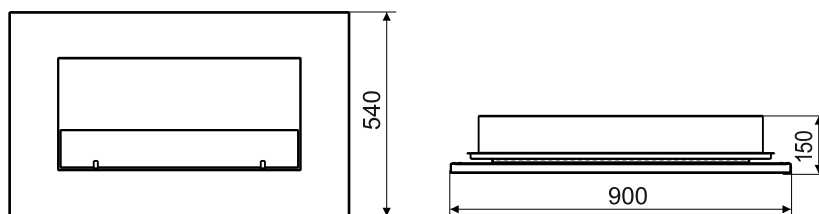

# OXFORD 700



<b>Finish</b>	<i>High gloss white, high gloss black, brushed stainless steel or chrome</i>
<b>Material</b>	<i>Steel, stainless steel and ROBAX® Glass</i>
<b>Weight</b>	<i>27 kg wall-mounted - 37 kg built-in</i>
<b>Burner Type</b>	<i>Wick burner</i>
<b>Tank Volume</b>	<i>2.88 litres</i>
<b>Min. Room Volume</b>	<i>111 m<sup>3</sup></i>
<b>Burning Duration</b>	<i>5 hours</i>

As one of the bestselling wall-mounted bio fireplaces of the ebios-fire® Designer Collection the Oxford Series features sleek, uncluttered lines which will enhance most contemporary settings. Both modern and smart, the Oxford series offers maximum practicality and safety at minimum installation effort.

Essentially a rectangular-shaped wall-hung fireplace with a low glass screen in front of the flames, the Oxford comes in two sizes: 600 and 700 which refer to the burner width in millimetres. This makes this series suitable for medium size and larger rooms.

Both Oxford models are also available as built-in fires, which leave only 50mm protruding out of the wall cavity.

## Wall mounted

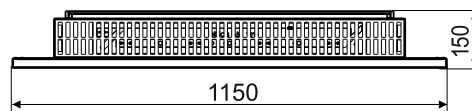
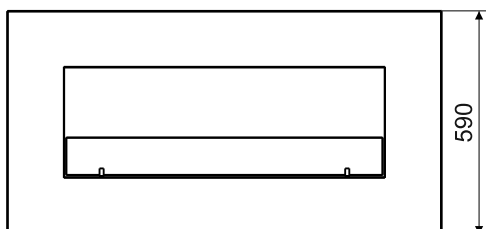

## Built-in

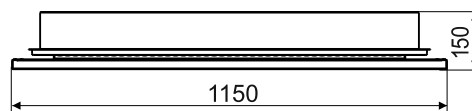
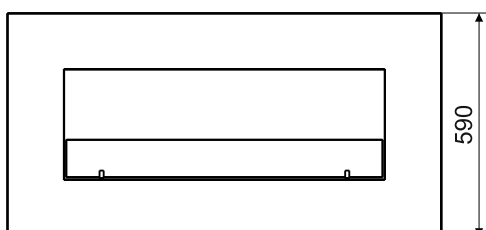

# CAMBRIDGE 400

---



<b>Finish</b>	<i>Black back panel and clear glass front</i>
<b>Material</b>	<i>Aluminium, stainless steel and Glass</i>
<b>Weight</b>	<i>19 kg</i>
<b>Burner Type</b>	<i>Wick burner</i>
<b>Tank Volume</b>	<i>1.65 litres</i>
<b>Min. Room Volume</b>	<i>65 m<sup>3</sup></i>
<b>Burning Duration</b>	<i>5 hours</i>

The two models of the ebios-fire® Cambridge Series come with a toughened glass panel front which is held by four solid, beautifully turned stainless steel rods.

The perfect accessory for contemporary living, the Cambridge fireplace models are ideal for installation in apartments, houses and commercial premises such as bars and restaurants. The two different burner sizes of 400mm and 600mm cater perfectly for smaller and medium room sizes.

The Cambridge series, like all models in the ebios-fire® Designer Collection, is fuelled by bioethanol - an environmentally friendly, renewable energy.

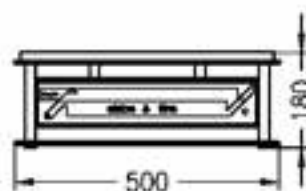
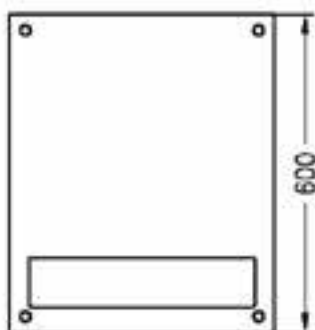

# CAMBRIDGE 600

---



<b>Finish</b>	<i>Black back panel and clear glass front</i>
<b>Material</b>	<i>Aluminium, stainless steel and Glass</i>
<b>Weight</b>	<i>27 kg</i>
<b>Burner Type</b>	<i>Wick burner</i>
<b>Tank Volume</b>	<i>2.47 litres</i>
<b>Min. Room Volume</b>	<i>96 m<sup>3</sup></i>
<b>Burning Duration</b>	<i>5 hours</i>

The two models of the ebios-fire® Cambridge Series come with a toughened glass panel front which is held by four solid, beautifully turned stainless steel rods.

The perfect accessory for contemporary living, the Cambridge fireplace models are ideal for installation in apartments, houses and commercial premises such as bars and restaurants. The two different burner sizes of 400mm and 600mm cater perfectly for smaller and medium room sizes.

The Cambridge series, like all models in the ebios-fire® Designer Collection, is fuelled by bioethanol - an environmentally friendly, renewable energy.

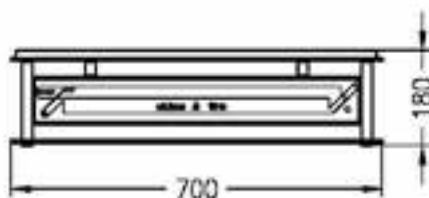
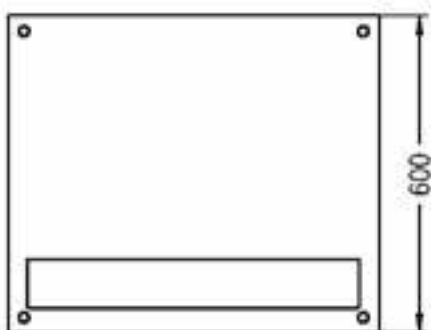

# ELIPSE Z

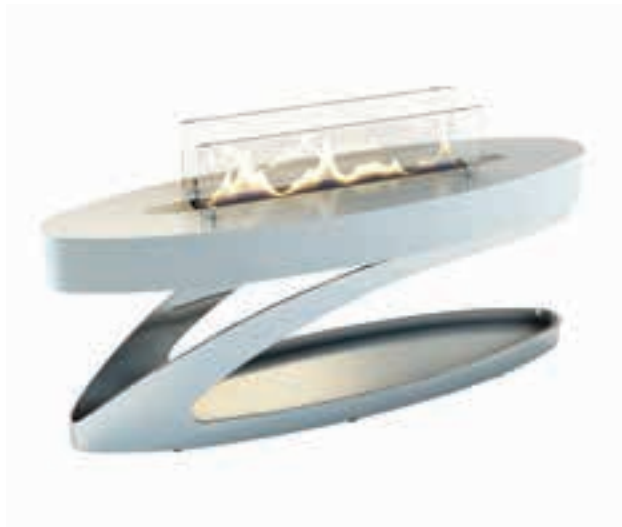

<b>Finish</b>	<i>High gloss white, high gloss black, matt white or matt black with chrome stand brushed stainless steel or chrome with black stand</i>
<b>Material</b>	<i>Steel, stainless steel and ROBAX® Glass</i>
<b>Weight</b>	<i>44.5 kg</i>
<b>Burner Type</b>	<i>Wick burner</i>
<b>Tank Volume</b>	<i>2.6 litres</i>
<b>Min. Room Volume</b>	<i>84 m<sup>3</sup></i>
<b>Burning Duration</b>	<i>5 hours</i>

The award-winning Elipse Z is one of the most popular ebios-fire® models. Decorated with the Plus X Award for High Quality and Design as “Product of the Year”, this elegant floor model can be placed anywhere in a room allowing a view of its mesmerising flames all around.

The Elipse Z features the patented wick-burner, which is considered the safest bioethanol burner on the market. The two lateral glass panels do not only protect the flames from air draught, but also beautifully reflect the calmly dancing flames.

Like all models of the ebios-fire® designer collection, the Elipse Z is fuelled by liquid bioethanol - an environmentally friendly, energy efficient biofuel – allowing you to enjoy a clean burning flame.

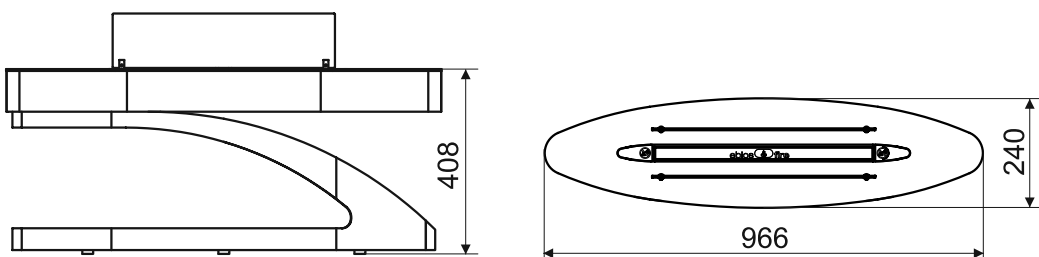



# ELIPSE CASE

---



---

<b>Finish</b>	<i>matt white or matt black with chrome side details</i>
<b>Material</b>	<i>Steel, stainless steel and ROBAX® Glass</i>
<b>Weight</b>	<i>41.5 kg</i>
<b>Burner Type</b>	<i>Wick burner</i>
<b>Tank Volume</b>	<i>2.6 litres</i>
<b>Min. Room Volume</b>	<i>84 m<sup>3</sup></i>
<b>Burning Duration</b>	<i>5 hours</i>

---

With its streamlined and clean lines, the Elipse Case beautifully combines function with style. Featuring chrome side details, which reflect details of the surrounding ambience, the Elipse Case is both modern and smart – designed to add sophistication to most contemporary surrounds.

With minimalist chic and maximum practicality, the Elipse Case allows a view of its mesmerizing flames from all angles. This stylish, freestanding piece of design features the patented wick-burner, which is considered the safest bioethanol burner on the market. The two reflective glass panels protect the flames from air draught, facilitating a line of beautifully mesmerising flames.

As with the rest of the ebios-fire® range of fireplace models, also the Elipse Case is fuelled by liquid bioethanol, an environmentally friendly, renewable source of energy.

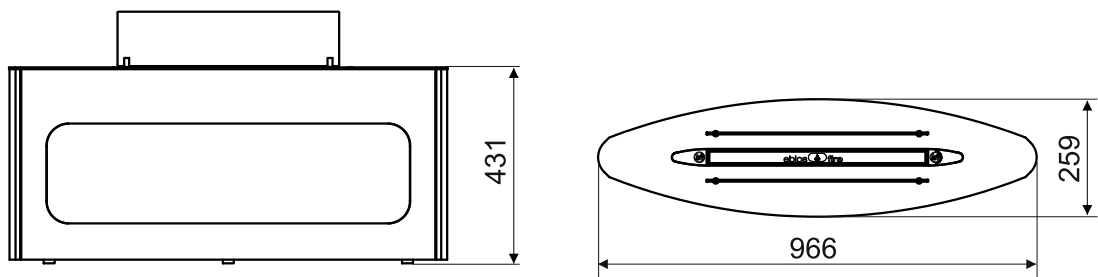

# ARCHITECTURE SL

---



---

**Finish** *concrete or sandstone stand and black burner housing*

---

**Material** *Steel, stainless steel concrete or sandstone and ROBAX® Glass*

---

**Weight** *Around 40 kg*

---

**Burner Type** *Wick burner*

---

**Tank Volume** *2.6 litres*

---

**Min. Room Volume** *84 m<sup>3</sup>*

---

**Burning Duration** *5 hours*

---

The ebios-fire® Architecture SL is designed with a minimalist appeal to enhance any contemporary décor in- or outdoors. Its distinctive and original material mix of concrete/sandstone and metal creates a chic object for apartments, houses, and residential units as well as in commercial premises like hotels, offices, restaurants and bars.

The unique and patented wick burner in its metal housing is suspended elegantly inside the stand construction made of concrete or crafted in sandstone. As with all ebios-fire® wick burners, two reflective Robax-Glass panels are shielding the fire from air draught, creating stunning multiplications of the flames.

Fuelled by bioethanol - an environmentally friendly, renewable source of energy - the Architecture SL, like any other ebios-fire® model burns clean and smoke-free.

For outdoors use, a protective cover is available on request for the Architecture SL. In severe weather conditions, however, this ebios-fire® model should be kept indoors.

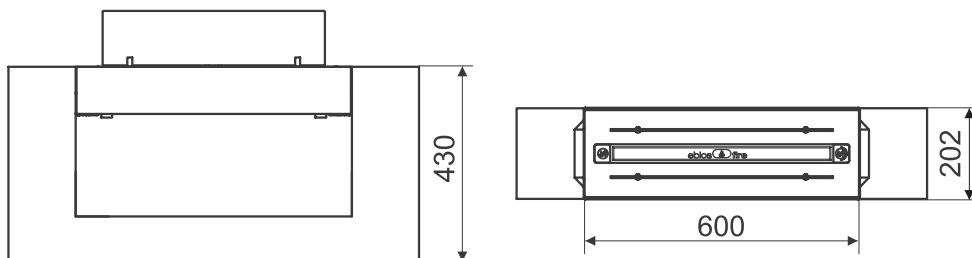

# TOWER



**Finish** *black, white, terra (dark brown) and Corten Steel*

**Material** *Steel, stainless steel and glass*

**Weight** *64 kg*

**Burner Type** *Automatic burner*

**Tank Volume** *2 x 5 litre jerry can*

**Min. Room Volume** *270 m<sup>3</sup>*

**Burning Duration** *6 hours*

The sleek appearance of the ebios-fire® Tower adorns any décor in- or outdoors. Owing to its effective heat output, this bioethanol fire model is popular on restaurant terraces, surrounding hotel or shop entrances providing a warm, welcoming atmosphere. Placed indoors, the Tower requires a rather larger room due to its heat output.

The automatic burner of the ebios-fire® Tower - operated by remote control – is fed from two bioethanol jerry cans which are conveniently stored in its housing underneath the burner. The flames are protected from wind by a heavy glass cylinder, which is covered with a glass plate at the top.

Fuelled by bioethanol - an environmentally friendly, renewable source of energy - the Tower, like any other ebios-fire® model burns clean and smoke-free.

For outdoors use, a protective cover is available on request. In severe weather conditions, however, this ebios-fire® model should be kept indoors.

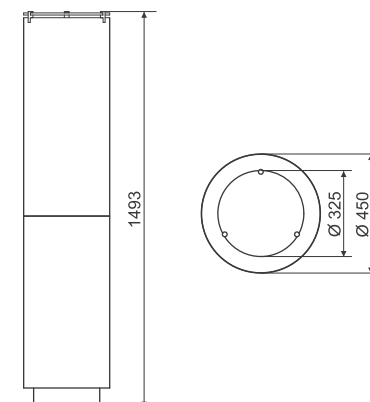

# QUADRA BASE

---



<b>Finish</b>	<i>Brushed stainless steel or black</i>
<b>Material</b>	<i>Steel, stainless steel and ROBAX® Glass</i>
<b>Weight</b>	<i>19 kg</i>
<b>Burner Type</b>	<i>Wick burner</i>
<b>Tank Volume</b>	<i>2.6 litres</i>
<b>Min. Room Volume</b>	<i>84 m<sup>3</sup></i>
<b>Burning Duration</b>	<i>5 hours</i>

Square, simple, sophisticated – and ideal for smaller spaces: The Quadra Base is the most compact of the ebios-fire® Designer Collection. Being portable, this freestanding fire - which has been designed as a table top model - can be moved from room to room.

Regardless of where it is placed, the Quadra Base clean lines and minimalist design make it a perfect addition to any living space. Its long, stainless steel firebox allows a wide flame picture, which is flanked by two hardened glass panels. Adding to safety, they create beautiful reflections of a ribbon-like calmly dancing fire.

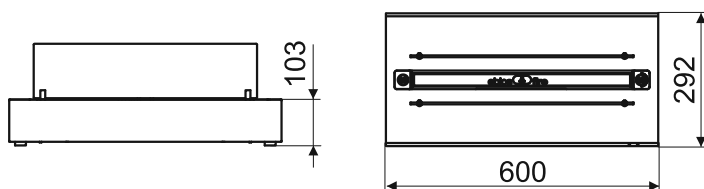

# ELIPSE BASE

---

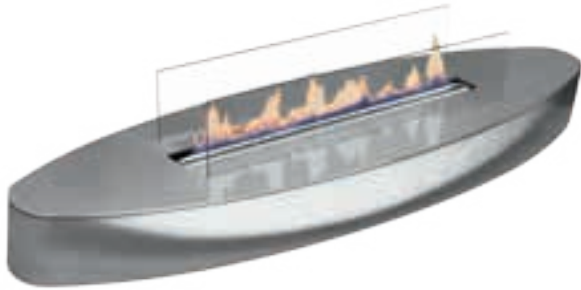

<b>Finish</b>	<i>High gloss white, high gloss black, matt white, matt black, brushed stainless steel or chrome</i>
<b>Material</b>	<i>Steel, stainless steel and ROBAX® Glass</i>
<b>Weight</b>	<i>19.5 kg</i>
<b>Burner Type</b>	<i>Wick burner</i>
<b>Tank Volume</b>	<i>2.6 litres</i>
<b>Min. Room Volume</b>	<i>84 m<sup>3</sup></i>
<b>Burning Duration</b>	<i>5 hours</i>

The ebios-fire® Elipse Base is a stunningly elegant bioethanol fireplace model, which adds design appeal to any décor – placed on a piece of furniture, a counter or any other form of elevation. Perfect for any size of indoor spaces, both residential and commercial, the Elipse Base features the patented wick-burner as well as two reflective glass panels, which allow the view of captivating flames from any angle.

Just as all ebios-fire® models, the Elipse Base is fuelled by clean-burning, environmentally friendly bioethanol.

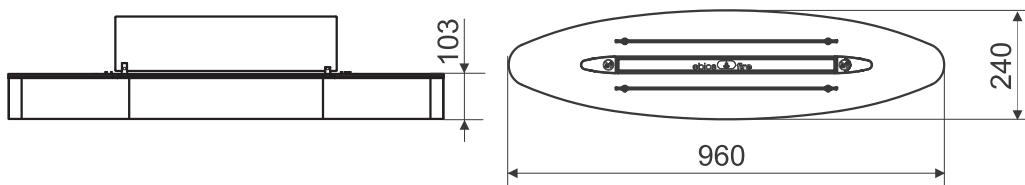

# FIRE BASE TABLE

---



<b>Finish</b>	<i>Chrome stand and clear glass top</i>
<b>Material</b>	<i>Aluminium, stainless steel and optic white glass</i>
<b>Weight</b>	<i>63 kg</i>
<b>Burner Type</b>	<i>Wick burner OR automatic burner</i>
<b>Tank Volume</b>	<i>2.6 litres</i>
<b>Min. Room Volume</b>	<i>185 m<sup>3</sup></i>
<b>Burning Duration</b>	<i>2 hours</i>

A really stunning fire object, the Fire Base Table from ebios-fire® makes gathering around the fire indoors a favourite past time.

Featuring a 10mm thick toughened safety glass plate resting on an elegantly formed chromed stand, the Fire Base Table can be equipped with an automatic or wick burner. A glass cylinder protects the flames from air draught.

Like all models of the ebios-fire® designer collection, the burner of the Fire Base Table is fuelled by liquid bioethanol - an environmentally friendly, energy efficient biofuel – allowing you to enjoy a clean burning flame.

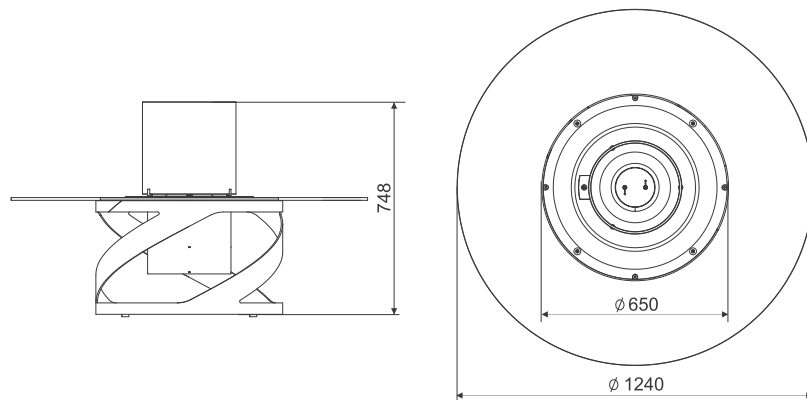

# FENIX BORA

---



<b>Finish</b>	<i>Mahogany optic with white details and smoky glass</i>
<b>Material</b>	<i>Steel, stainless steel and glass</i>
<b>Weight</b>	<i>73 kg</i>
<b>Burner Type</b>	<i>Automatic burner</i>
<b>Tank Volume</b>	<i>2 x 5 litre jerry can</i>
<b>Min. Room Volume</b>	<i>84 m<sup>3</sup></i>
<b>Burning Duration</b>	<i>50 hours - automatic turn-off after max. 8 hours of continuous operation</i>

With its design being reminiscent of the Riva speedboats of the 50s, the ebios-fire® Fenix Bora elegantly combines the elements water and fire.

Its automatic bioethanol burner makes operation of the fire easy as well as safe, whereby the fuel is fed from jerry cans hidden in a customised podium on which the Fenix Bora rests.

This impressive fire object adorns Marinas and Luxury Hotels all around the world.

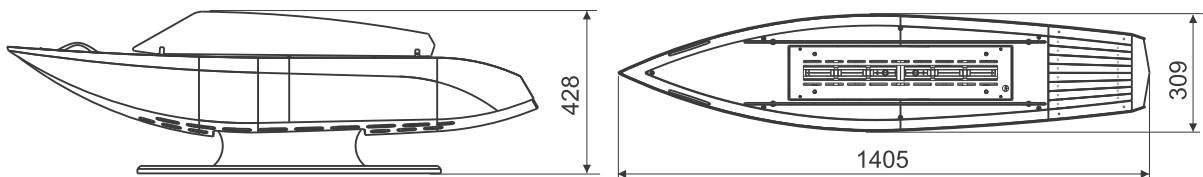

# FENIX SCIROCCO

---



<b>Finish</b>	<i>Mahogany optic with white details and smoky glass</i>
<b>Material</b>	<i>Steel, stainless steel and glass</i>
<b>Weight</b>	<i>130 kg</i>
<b>Burner Type</b>	<i>Automatic burner</i>
<b>Tank Volume</b>	<i>2 x 5 litre jerry can</i>
<b>Min. Room Volume</b>	<i>170 m<sup>3</sup></i>
<b>Burning Duration</b>	<i>25 hours - automatic turn-off after max. 8 hours of continuous operation</i>

---

Impressive in size and design, the ebios-fire® Fenix Scirocco elegantly combines the contrasting elements of fire and water.

Its automatic bioethanol burner makes operation of the fire easy as well as safe, whereby the fuel is fed from jerry cans hidden in a customised podium on which this fire object rests.

This impressive fire object adorns Marinas and Luxury Hotels all around the world.

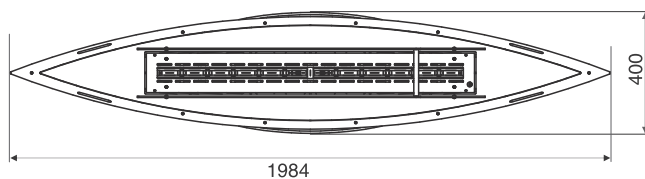
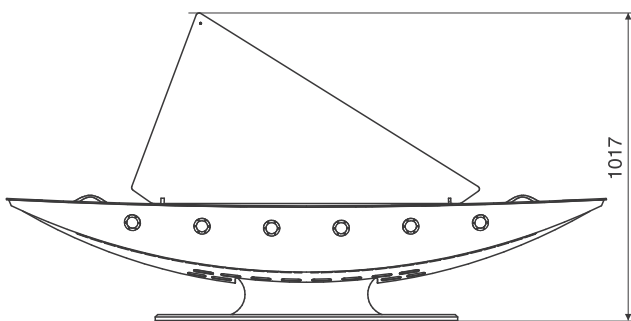



# LIBERTY

---



<b>Finish</b>	<i>Bronze optic</i>
<b>Material</b>	<i>Steel, stainless steel and lava stones</i>
<b>Weight</b>	<i>78 kg</i>
<b>Burner Type</b>	<i>Automatic burner</i>
<b>Tank Volume</b>	<i>2 x 5 litres jerry can</i>
<b>Min. Room Volume</b>	<i>270 m<sup>3</sup></i>
<b>Burning Duration</b>	<i>6 hours</i>

Inspired by the famous icon Statue of Liberty, the ebios-fire® Liberty celebrates the combination of art and fire. This luxurious fire object is made of steel in bronze optic and features an automatic bioethanol burner – operated by remote control - which is fed by fuel kept in jerry cans resting in its base.

As an impressive sculptural statement, the ebios-fire® Liberty welcomes guests in hotels, restaurants and private residences worldwide.

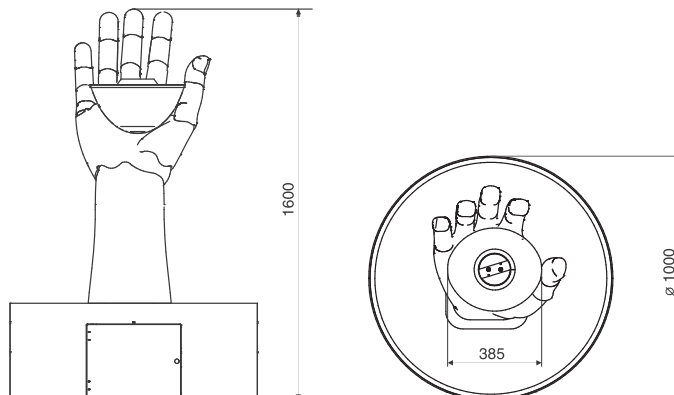

# ARCHITECTS COLLECTION

Catering especially for the requirements of architects and interior designers, the ebios-fire® Architects Collection contains a large number of bioethanol burners, fireplace inserts as well as made to measure built-in fireplaces in a number of layouts and finishes. Choosing between manual wick burners or electronically controlled bioethanol burners, creating a stunning fire feature without the necessity of a flue or chimney becomes remarkably simple with an ebios-fire® bioethanol fireplace.

---



*As a made to measure fireplace solution, the ebios-fire® Chelsea is available in a wealth of layouts with various frame finishes.*

# FROM SKETCH TO REALITY

Regardless of whether you are planning a feature fire for your client's office or home, a hotel, a restaurant or your own residence: the made to measure range of ebios-fire® bioethanol fireplaces offers a wealth of layout, finishes and possibilities. Without the necessity for a flue, chimney or bearing wall a custom-made fireplace from ebios-fire® is an easy way to create a stunning focal point.

Turning your ideas and dreams from a simple sketch into a stunning reality is what our experts are here to do. Just share your ideas with us and we will assist with suggestions for a save and functional implementation of an ebios-fire® bioethanol fireplace in your project.





# BUILT-IN FIREPLACES

The ebios-fire® built-in fireplaces offer themselves for installations in wall constructions of brick, gas concrete or fibre plasterboard, whereby the wall is constructed around the fireplace without the need for a flue or chimney.

They are available in six different layouts and various sizes, which can accommodate either the manual wick burner or the automatic burner from ebios-fire®.

Reflective SCHOTT ROBAX® glass panels surrounding the flames complete the look.



<b>Finish</b>	<i>Powder-coated nero with black glass panel as frame and back panel</i>
<b>Material</b>	<i>Steel, black glass and isolation material</i>
<b>Weight</b>	<i>From 73 kg to 93 kg – depending on layout</i>
<b>Burner Type</b>	<i>Wick burner or automatic burner</i>
<b>Tank Volume</b>	<i>2.6 litres or two jerry cans</i>
<b>Min. Room Volume</b>	<i>84 m<sup>3</sup></i>
<b>Burning Duration</b>	<i>5 hours</i>

## LAYOUT

TV

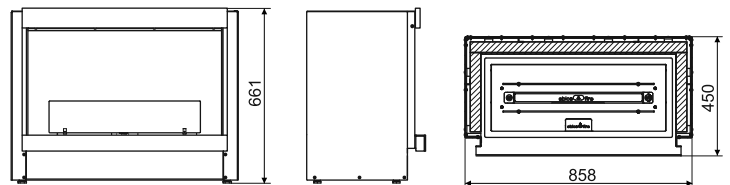
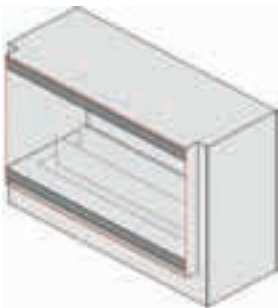

FD

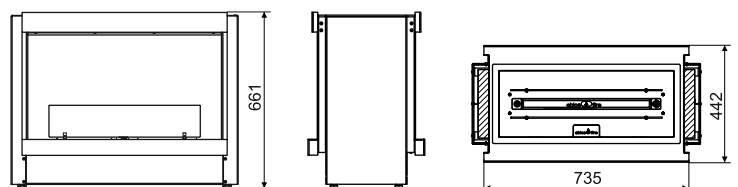
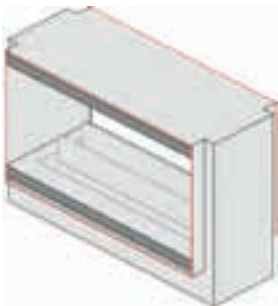

2R

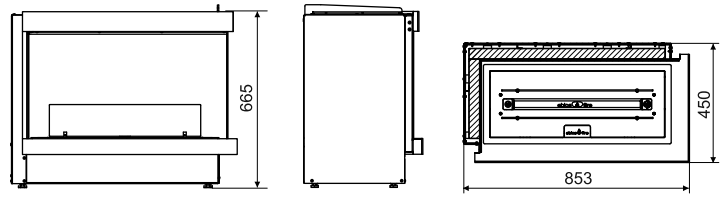
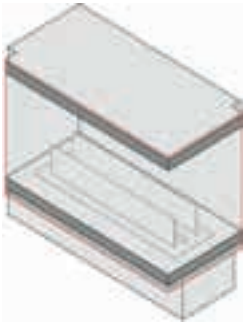

2L

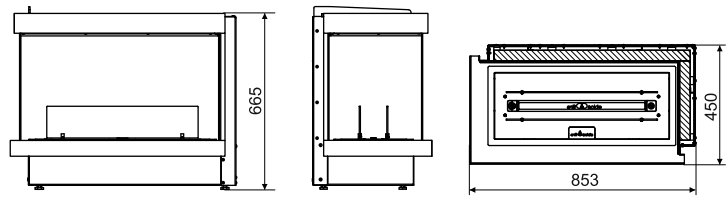
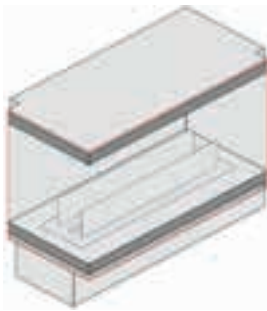

U

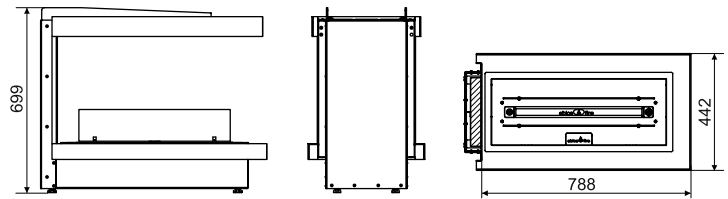
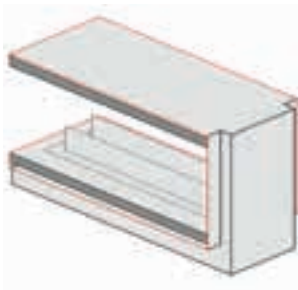

C

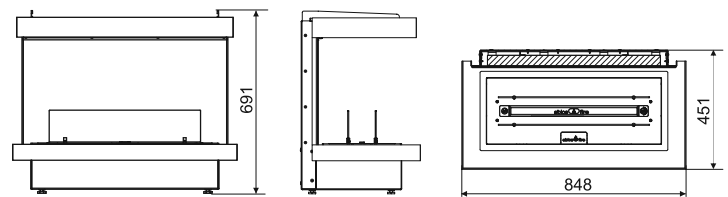
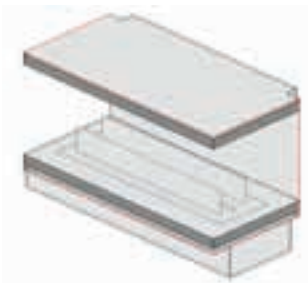



**“ THE PRIMARY  
FACTOR IS  
PROPORTIONS.”**

*ARNE JACOBSEN*

# MADE TO MEASURE FIREPLACE INSERTS

Designed to fit into existing wall openings or custom-made cavities in walls constructed of fibre plasterboard (stud walls), gas concrete or brick, the fireplace inserts from ebios-fire® are made to measure solutions, which offer a wealth of options. Dimensions and layouts can be adapted to suit any flue-less fire application.

Glass panels in optic white hardened glass in front of the opening/s of the fireplace are recommended in order to protect the flames from draught.

These easily installed fireplace inserts can be equipped with either the manual wick burner or the automatic burner from ebios-fire® and require a minimum wall depth of 270mm.

Two choices of design are available: model Kensington in a timeless, no-fuss, minimalist appearance and model Chelsea which features a 50mm wide frame in brushed stainless steel, which can also be made in other metals like copper or brass as well as in other colours on request.

Each fireplace insert comes with a detailed technical drawing as well as step-by-step installation guide.

# KENSINGTON

## LAYOUT EXAMPLES



Kensington open to front



Kensington open to front and back

<b>Finish</b>	<i>Powder-coated black</i>
<b>Material</b>	<i>Aluminium and optic white, hardened glass</i>
<b>Weight</b>	<i>Depending on layout</i>
<b>Burner Type</b>	<i>Wick burner or automatic burner</i>
<b>Tank Volume</b>	<i>≥ 2.6 litres or two jerry cans – depending on burner size</i>
<b>Min. Room Volume</b>	<i>≥ 84 m<sup>3</sup></i>
<b>Burning Duration</b>	<i>5 hours</i>

### Kensington with Automatic burner

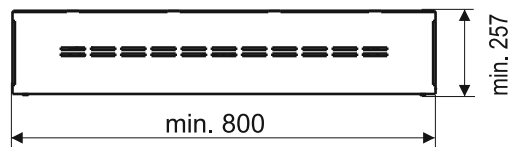
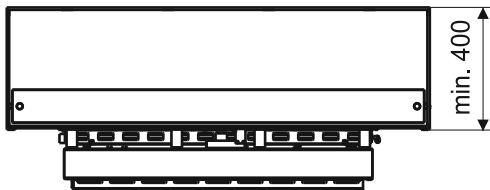

### Kensington with Wick burner

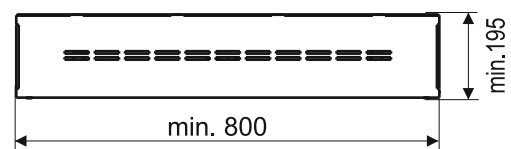

# CHELSEA

## LAYOUT EXAMPLE

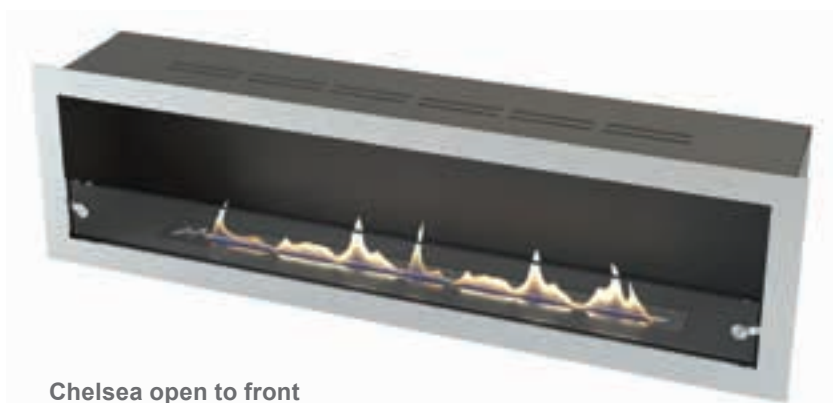

Chelsea open to front

<b>Finish</b>	<i>Powder-coated black with brushed stainless steel frame</i>
<b>Material</b>	<i>Aluminium, stainless steel and optic white, hardened glass</i>
<b>Weight</b>	<i>Depending on layout</i>
<b>Burner Type</b>	<i>Wick burner or automatic burner</i>
<b>Tank Volume</b>	<i>≥ 2.6 litres or two jerry cans – depending on burner size</i>
<b>Min. Room Volume</b>	<i>≥ 84 m<sup>3</sup></i>
<b>Burning Duration</b>	<i>5 hours</i>

### Chelsea with Automatic burner

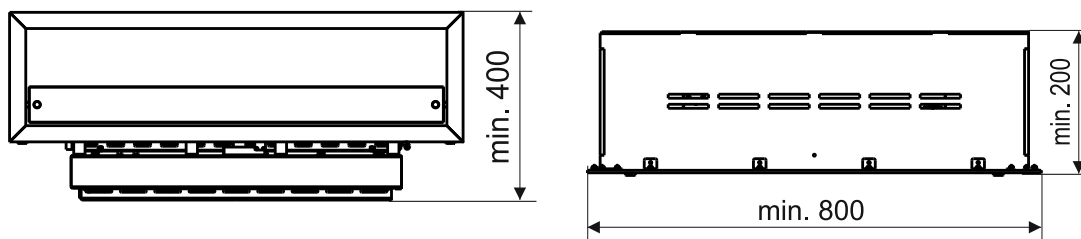

### Chelsea with Wick burner

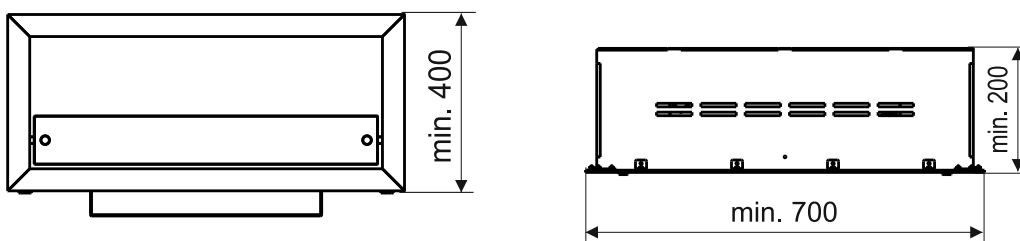

**“A HOUSE THAT  
DOES NOT HAVE  
ONE WARM, COM-  
FORTING FIRE IN IT  
IS SOULLESS.”**

*MAY SARTON*











# QUADRA DROP-IN

---

The ebios-fire® Quadra Drop-in combines one or more burners with an installation frame allowing trouble-free drop-in installation. The Quadra Drop-in is available in sizes accommodating one, two or three burners next to each other. Each features a patented wick-feeding technology which allows a safe, deflagration-free ignition.

This burner type has been safety tested and approved by TÜV Germany against the German Standard DIN 4734-1 – it can be considered one of the safest bioethanol burners currently on the market.



SCHOTT ROBAX® glass panels surrounding the burner do not only reflect the mesmerising flames beautifully but also add to safety and functionality of the burner/s.

## SAFETY FEATURES

- pressure tested tank assembly
- glass gauge with fuel level indicator
- screw-cap for fuel inlet
- pressure valve
- sealed fuel tank and wick system prevents fuel spillage if tilted

---

## EXAMPLE QUADRA DROP-IN I / II / III

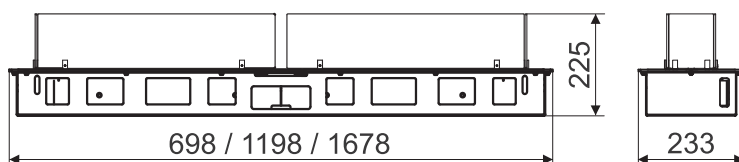

## QUADRA DROP-IN I

---

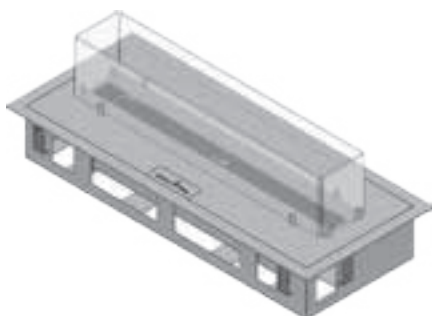

<b>Finish</b>	<i>Brushed stainless steel or black</i>
<b>Material</b>	<i>Steel, stainless steel and ROBAX® Glass</i>
<b>Weight</b>	<i>18.5 kg (incl. fuel)</i>
<b>Burner Type</b>	<i>Wick burner</i>
<b>Tank Volume</b>	<i>2.6 litres</i>
<b>Min. Room Volume</b>	<i>84 m<sup>3</sup></i>
<b>Burning Duration</b>	<i>5 hours</i>

## QUADRA DROP-IN II

---



<b>Finish</b>	<i>Brushed stainless steel or black</i>
<b>Material</b>	<i>Steel, stainless steel and ROBAX® Glass</i>
<b>Weight</b>	<i>33 kg (incl. fuel)</i>
<b>Burner Type</b>	<i>Wick burner</i>
<b>Tank Volume</b>	<i>2 x 2.6 litres</i>
<b>Min. Room Volume</b>	<i>168 m<sup>3</sup></i>
<b>Burning Duration</b>	<i>5 hours</i>

## QUADRA DROP-IN III

---



<b>Finish</b>	<i>Brushed stainless steel or black</i>
<b>Material</b>	<i>Steel, stainless steel and ROBAX® Glass</i>
<b>Weight</b>	<i>47.5 kg (incl. fuel)</i>
<b>Burner Type</b>	<i>Wick burner</i>
<b>Tank Volume</b>	<i>3 x 2.6 litres</i>
<b>Min. Room Volume</b>	<i>252 m<sup>3</sup></i>
<b>Burning Duration</b>	<i>5 hours</i>

# QUADRA DROP-IN AUTOMATIC

---

The ebios-fire® Quadra Drop-in Automatic burner featuring pumps which feed bioethanol into a trough of either 500 or 1000mm width can be operated by remote control (on/off). The fuel supply is either kept in 5 liter jerry cans which are placed either underneath the fire or at a remote location. Alternatively, the burner can feature a tank which then is an integral part of the appliance.

SCHOTT ROBAX® glass panels surrounding the burner do not only reflect the mesmerising flames beautifully but also add to safety and functionality of the burner/s.

## TECHNICAL FEATURES

- silent ignition
- operation via radio remote control
- fuel level sensor in flame tray
- humidity sensors at critical locations (leakage detectors)
- temperature sensors (no flame, no fuel and automatic cut-off if overheating)
- automatic cut-off after 8 hours of operation
- acoustic error signal
- automatic shut-down as soon as fuel inlet is opened

---

## EXAMPLE QUADRA DROP-IN AUTOMATIC I / II

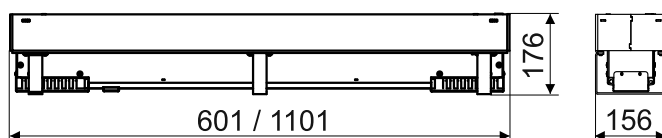

## QUADRA DROP-IN AUTOMATIC I

---



<b>Finish</b>	<i>Brushed stainless steel or black</i>
<b>Material</b>	<i>Steel, stainless steel and ROBAX® Glass</i>
<b>Weight</b>	<i>13 kg</i>
<b>Burner Type</b>	<i>Automatic burner</i>
<b>Tank Volume</b>	<i>Two 5 litre jerry cans</i>
<b>Min. Room Volume</b>	<i>84 m<sup>3</sup></i>
<b>Burning Duration</b>	<i>Automatic cut-off after 8 hours of continuous operation</i>

---

## QUADRA DROP-IN AUTOMATIC II

---



<b>Finish</b>	<i>Brushed stainless steel or black</i>
<b>Material</b>	<i>Steel, stainless steel and ROBAX® Glass</i>
<b>Weight</b>	<i>20 kg</i>
<b>Burner Type</b>	<i>Automatic burner</i>
<b>Tank Volume</b>	<i>Two 5 litre jerry cans</i>
<b>Min. Room Volume</b>	<i>186 m<sup>3</sup></i>
<b>Burning Duration</b>	<i>Automatic cut-off after 8 hours of continuous operation</i>

---

# FIRE BASE DROP-IN

---



<b>Finish</b>	<i>Brushed stainless steel</i>
<b>Material</b>	<i>Stainless steel and toughened glass</i>
<b>Weight</b>	<i>10 kg (incl. fuel)</i>
<b>Burner Type</b>	<i>Wick burner</i>
<b>Tank Volume</b>	<i>2.6 litres</i>
<b>Min. Room Volume</b>	<i>185 m<sup>3</sup></i>
<b>Burning Duration</b>	<i>2 hours</i>

The ebios-fire® Fire Base Drop-in is a round burner featuring wick-feeding technology. It is easily installed in any level surface in- or outdoors. A sturdy glass cylinder protects the flames from air draughts.

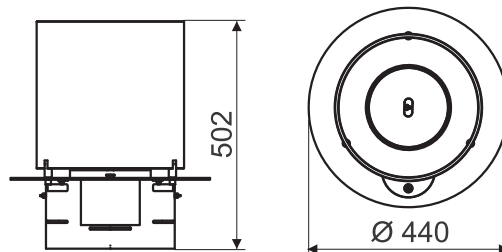

# FIRE BASE DROP-IN AUTOMATIC

---



<b>Finish</b>	<i>Brushed stainless steel</i>
<b>Material</b>	<i>Stainless steel and toughened glass</i>
<b>Weight</b>	<i>12 kg (incl. fuel) or 9.5 kg</i>
<b>Burner Type</b>	<i>Automatic burner (driven by battery pack)</i>
<b>Tank Volume</b>	<i>2.6 litres or fuel supplies from 5 litre jerry cans</i>
<b>Min. Room Volume</b>	<i>185 m<sup>3</sup></i>
<b>Burning Duration</b>	<i>2 hours</i>

The ebios-fire® Fire Base Drop-in Automatic is a round automatic burner which can be supplied with a tank or alternatively with fuel supply from a 5 litre jerry can. Operation of this beautifully crafted fire is done by radio remote control.

The Fire Base Drop-in Automatic is easily installed in any level surface indoors. A sturdy glass cylinder protects the flames from air draughts.

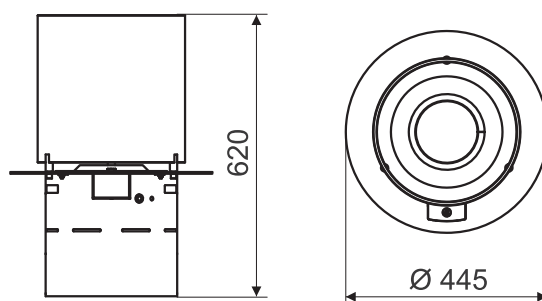



.....

Spartherm Feuerungstechnik GmbH

Maschweg 38

D-49324 Melle

Tel. +49 5422 9441-0

Fax +49 5422 9441-14

[info@ebios-fire.com](mailto:info@ebios-fire.com)

[www.ebios-fire.com](http://www.ebios-fire.com)

